

eduard
MASK

B-18 1/72

The die-cut mask for accurate canopy frame painting of the
Special Hobby scale 1/72 KIT

CX 348

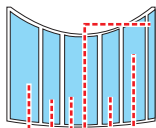
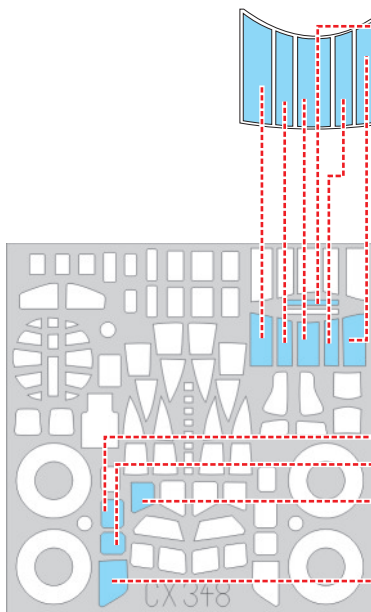
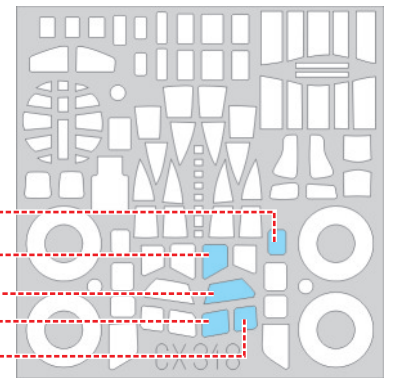
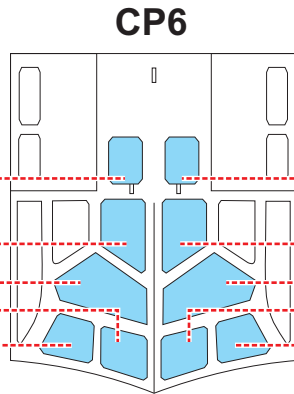
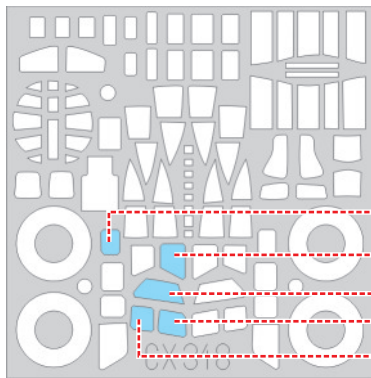
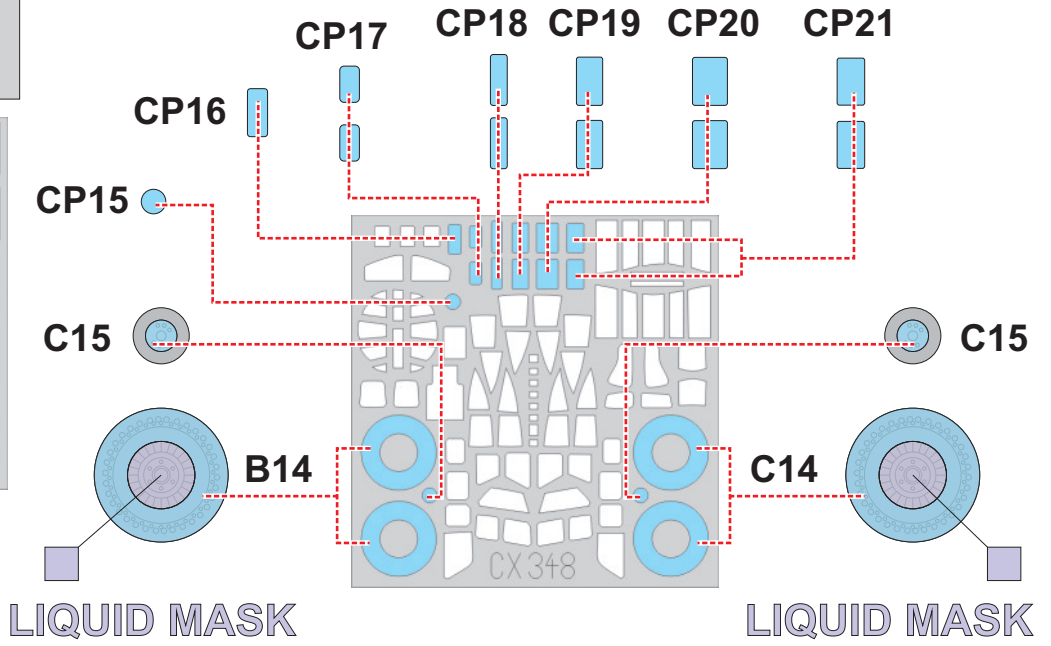
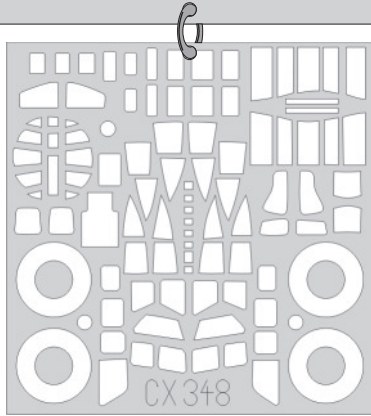

CP1

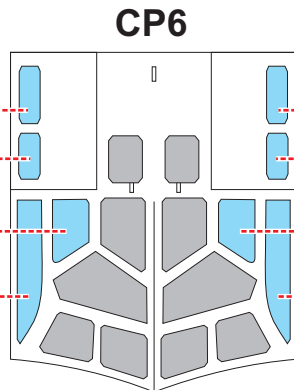

CP6

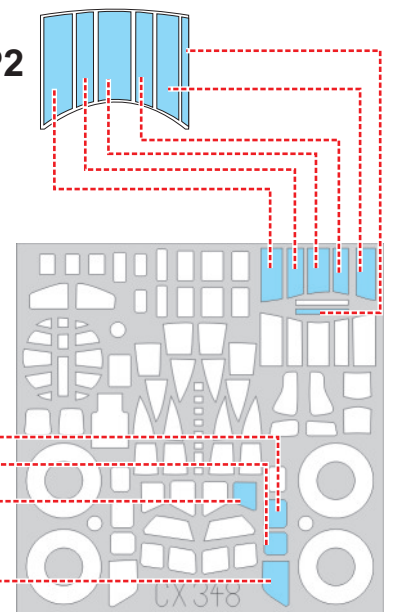

CP2

